

FA 500

The **CS dew point sensor FA 500** with 3-wire technology 4...20 mA and RS 485 Modbus output enables a reliable and long-term stable monitoring of the dew point in industrial applications such as in

- compressed air plants (refrigerating/adsorption dryers)
- granulate dryers
- medical gases
- non-corrosive gases, e. g. nitrogen



Table of Content

1	Safety Instructions	4
2	Description	5
3	Technical data.....	6
4	Dimension	7
5	Electrical wiring	8
6	Installation.....	9
6.1	Installing directly into the process	10
7	Modbus.....	11
7.1	Register Mapping measuring values	11
7.2	Modbus Settings (2001...2006).....	12
7.3	Analog Scaling Settings (2007...2011).....	12
8	Operation.....	13
8.1	Initialization	13
8.2	Main menu	13
8.3	Settings	14
8.3.1	Sensor Settings.....	15
8.3.2	Definition of Reference- and System pressure	16
8.3.3	Modbus Setup	19
8.3.4	Alarm.....	20
8.3.5	User Setup.....	21
8.3.6	4 -20mA.....	22
8.3.7	FA 500 Info.....	24
9	Calibration / Adjustment.....	25
10	Warranty.....	25
11	Ordering details	26

Dear CS customer,

You have made the right decision by choosing a measuring instrument of CS Instruments GmbH. Thousands of customers buy our high standard products every year. There are a few good reasons for doing so:

- Cost-performance ratio. Reliable quality at a fair price.
- We have the ideal solutions for your measuring tasks based on our expert experience gained over 20 years.
- Our high quality standard.
- Of course, our instruments carry the CE symbol required by the EU.
- Calibration certificates, trainings, consultation and calibration on location.
- Our after sales-service, we do not leave you out in the cold.

Our service guarantees fast help.

 Measuring instrument conforms to **DIN EN 61326-1**

1 Safety Instructions

Please read prior to operation!



Warning: Do not exceed a pressure range of > 50 bar with standard version. With special versions up to 350 bar.

Observe measuring ranges of sensor! The probes are damaged if they are overheated.

Observe max. storage and transport temperature as well as max. operating temperature (e. g. protect measuring instrument from direct sunlight).

Warranty claims no longer apply if the instrument is opened, in the case of inexpert handling or use of force.

Adjustments or calibrations should be carried out by qualified measurement and control engineering staff only.

Important: Before installation briefly bleed the compressed air in order to remove condensate and particles. This prevents soiling of FA 500. Standing air leads to long measuring times.

2 Description

The FA 500 (from -80 to 20 °Ctd) is the ideal dew point meter with integrated display and alarm relay for refrigeration, membrane and adsorption driers.

The FA 500 dew point sensor enables a reliable and long-term stable monitoring of the dew point in industrial applications from -80 to +20 °C dew point. The FA 500 features improved stability.

When mounting FA 500 into compressed air systems the pressure dew point (dew point under pressure) up to 50 bar (in the special version up to 350 bar) is measured directly. When mounting FA 500 in atmospheric conditions (ambient pressure) or in the flow off sector (relaxed air) of compressed air systems the atmospheric dew point is measured.

Advantages:

- Dew point sensor for very low dew points down to -80 °Ctd
- Extremely long-term stable due to internal automatic calibration
- IP 65 housing grants a reliable protection in extreme industrial conditions
- Very fast response time
- Installable in the dryer by means of G 1/2" thread, optional UNF 5/8" or NPT 1/2"
- High accuracy of ± 2 °Ctd
- Calibration on location and testing with CS control and calibration set (PC connection set)

Programming via Software.

With the CS Service Software incl. USB / Modbus Adapter the Modbus settings, the scaling of the Analogue output and the assignment of the measurement values could be set.

- Analogue output 4...20 mA scalable
- Switching between °Ctd, °Ftd, % RH, °C, °F, g/m³, mg/m³, g/kg, ppm, and so on
- Calibration and adjustment
- Sensor diagnosis
- Read-out of service data

3 Technical data

Measuring range	-80...20 °Ctd pressure dew point resp. dew point in °Ctd 0...100 % RH -20...70 °C
Type 0699.0502, FA 500	-80...20 °Ctd \triangleq 4...20 mA
Type 0699.0501, FA 500	-20...50 °Ctd \triangleq 4...20 mA Other scales on request, for example, -60 ... 30 ° Ctd \triangleq 4 ... 20 mA
Accuracy:	typical ± 1 °Ctd von 50...-20 °Ctd ± 2 °Ctd von -50...-20 °Ctd ± 3 °Ctd von -50...-80 °Ctd
Pressure range:	-1...50 bar standard
Power supply:	24V VDC (10..30 VDC)
Output:	4...20 mA 3-wire technology** RS 485 (Modbus RTU) **
Protection class:	IP 65
EMV:	DIN EN 61326
Operating temperature:	-20...70 °C (ideal 0...50 °C)
Storage temperature:	-40...80 °C
Load for analogue output:	< 500 Ohm
Screw-in thread:	G 1/2" stainless steel Optional: UNF 5/8" or NPT 1/2"
Material of housing:	PA 66 GF
Sensor protection:	sinter filter 50 μ m stainless steel
Connection:	M12, 5-pole
Response time t95:	< 30 seconds (descending) < 10 seconds (ascending)
Display:	1,8" TFT
Alarm relay	max. 60V, 0,5A (AC* / DC) NC relay, relays is closed in case of alarm and power failure. Alarm value adjustable via keyboard. See Chapter Operation.

* Peak AC

** **Remark:** Parallel use of analogue 4...20mA and RS 485 Modbus output is possible

4 Dimension

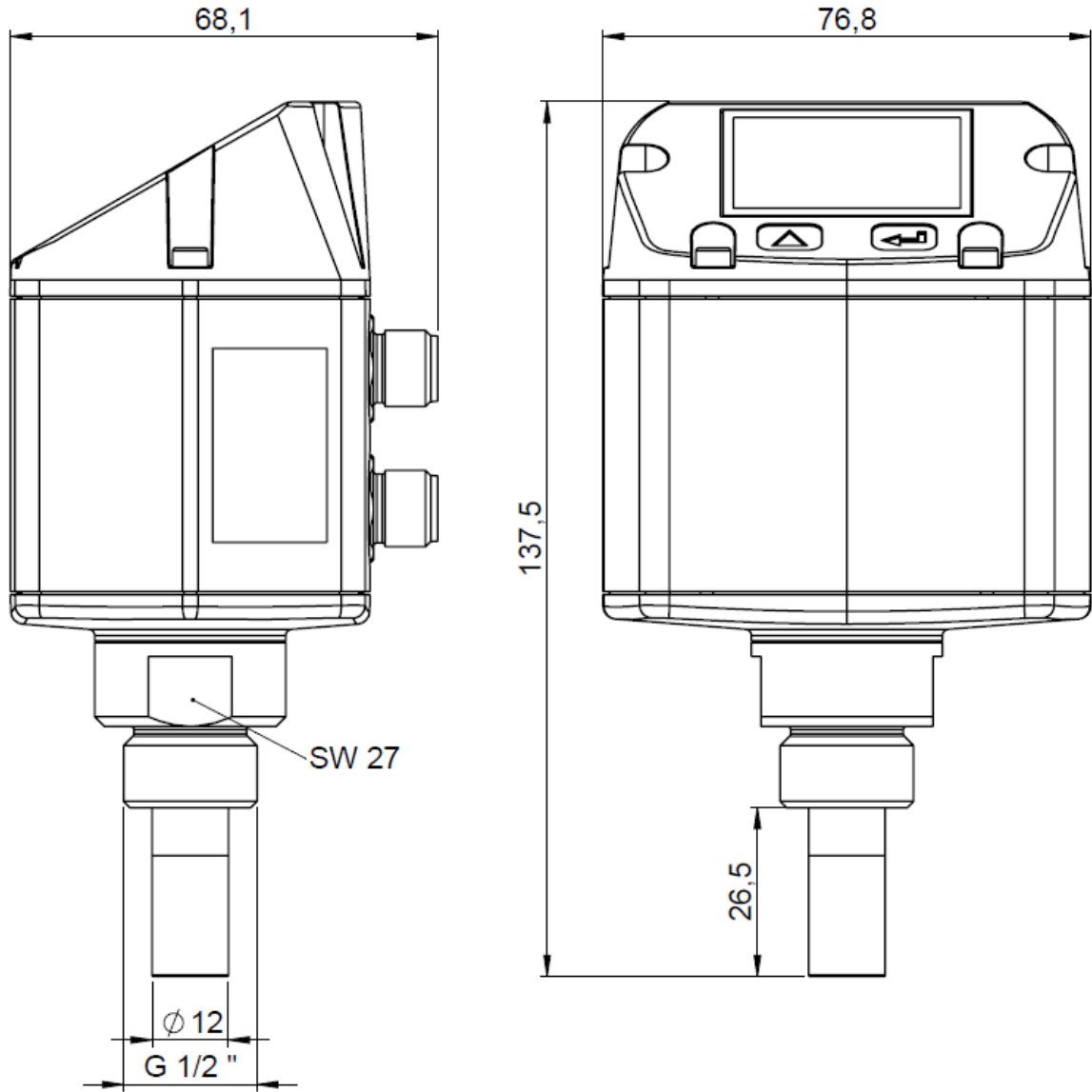

5 Electrical wiring

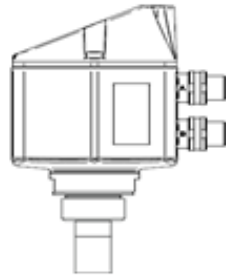

- Connector plug A (Supply and signals)

- Connector plug B (Alarm)

Attention: Not required connections NC must not be connected to a voltage and/or to protection earth. Cut and insulate cables.

	Pin 1	Pin 2	Pin 3	Pin 4	Pin 5
Connector plug A	+VB	RS 485 (A)	-VB	RS 485 (B)	I+ 4..20 mA
Connector plug B Alarm output (standard)	NC	NC	NC	Relay	Relay
Connector plug B Option MBus	NC	NC	NC	MBus	MBus
Connection cables colours 0553 0106 (5 m) 0553.0107 (10 m)	brown	white	blue	black	grey

Legend:

-VB	Negative supply voltage 0 V
+VB	Positive supply voltage 18...36 VDC smoothed
I +	Current signal 4...20 mA – selected measured signal
RS 485 (A) RS 485 (B)	Modbus RTU A Modbus RTU A

Relay	Alarm relay (normally closed) output 60V, 0.5A (AC / DC) for AC peak value
NC	Must not be connected to a voltage and/or to protection earth. Please cut and isolate cables.
MBus	MBus (reverse polarity protected)

If no connection cable/pulse cable is ordered the sensor will be supplied with a M12 connector plug. The user can connect the supply and signal cables as indicated in the connection diagram.

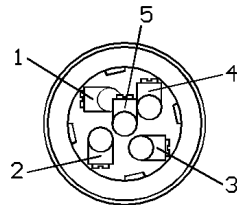

M12 Connector plug
View from back side
(terminal side)

Connector plug A (M12 - A-coding)

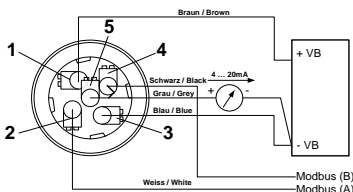

Connector plug B (M12 - A-coding)

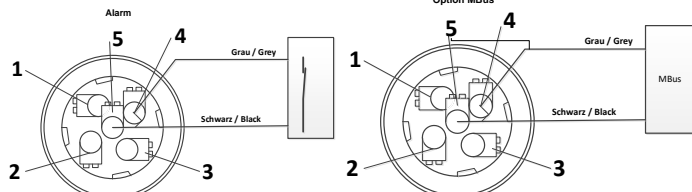

Remark: If the sensor is placed at the end of the Modbus system a termination is required. The sensors have an internal switchable termination, therefore the 6 fastening screws from the lid are to be released and set the internal DIP Switch to "On". It must be ensured that the connection plugs are still plugged and the gasket is installed correctly.

Alternatively, a 120R resistor can be installed in the plug between pin 2 and pin 4.

Remark: The sensor must be connected only in strain less state.

6 Installation

Please note: CS recommends the indirect installation with measuring chamber

Advantage: Easy mounting and dismounting of the probe without interruption of the line. Quick response time due to quick coupling. Optimum sensor protection.

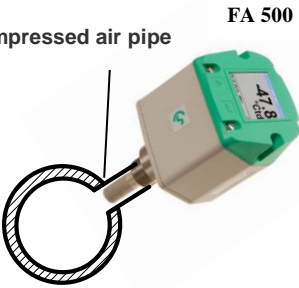
	<p>Indirectly in the compressed air system</p> <p>Connect probe with measuring chamber to the compressed air pipe by means of a quick coupling. In case of compressed air containing oil and dirt particles a pre-filter should be installed in front of the measuring chamber. Compressed air flows continuously (at 7 bar approx. 1 l/min expanded) in the capillary pipe of the measuring chamber. The reaction times for the humidity reading are shorter than in case of a direct mounting.</p>
	<p>Directly in the compressed air system</p> <p>Screw in probe with G 1/2" thread pressure-tight in the center or at the top of the compressed air pipe. Take care that measurement is effected close to the compressed air flow. U-bend pipes or non-flowing compressed air, result in very slow reaction times for the moisture reading.</p>
	<p>Measurable gases</p> <p>In general, humidity can be measured in all non-corrosive gases. In case of measurements in corrosive gases please consult CS Instruments GmbH</p>

6.1 Installing directly into the process

If installing directly in the process must be done in the depressurized state of the line, e.g. by using a stop valve should at both sides of the installation point.

This makes it easy to remove the transmitter for maintenance and calibration.



Insert the probe into the process and screw it as tight as possible by hand. If there is a sealing ring, check the correct centering and tighten the screw connection with a torque of 25-30 Nm..

It is not permitted to use a sealing ring with a NPT 1/2" thread. Appropriate PTFE sealing tape or sealant should be used instead..

7 Modbus

The dew point sensor FA 500 comes with a Modbus RTU Interface.
Before commissioning of the sensor the communication parameters

Modbus ID, Baud rate, Parity und Stop bit

must be set in order to ensure the communication with the Modbus master.

The adjustment can be done either with the CS Instruments PC service software, DS 400, DS 500 and the hand-held instrument PI 500 done.

Modbus communication default values:

- Modbus ID : 1 (1 -247)
- Baudrate: 19200 bps (1200,2400, 4800, 9600, 19200, 38400 bps)
- Parity: even (none, even, odd)
- Stopbit: 1 (1,2)

Supported are following function codes:

- Function code 03: Read Holding Register
- Function code 16: Write multiple Register

7.1 Register Mapping measuring values

Modbus Register	Modbus Address	No.of Byte	Data Type	Description	Default Setting	Read Write	Unit /Comment
1001	1000	4	Float	Temperature		R	[°C]
1003	1002	4	Float	Temperature		R	[°F]
1005	1004	4	Float	Relative Humidity		R	[%]
1007	1006	4	Float	Dew Point		R	[°Ctd]
1009	1008	4	Float	Dew Point		R	[°Ftd]
1011	1010	4	Float	Absolute Humidity		R	[g/m ³]
1013	1012	4	Float	Absolute Humidity		R	[mg/m ³]
1015	1014	4	Float	Humidity Grade		R	[g/kg]
1017	1016	4	Float	Vapor Ratio (Volume)		R	[ppm]
1019	1018	4	Float	Saturation vapor pressure		R	[hPa]
1021	1020	4	Float	Partial Vapor Pressure		R	[hPa]
1023	1022	4	Float	Atmospheric DewPoint		R	[°Ctd]
1025	1024	4	Float	Atmospheric DewPoint		R	[°Ftd]

Remark for DS400 / DS 500 / Handheld devices - Modbus Sensor Datatype:

„Data Type R4-32“ match with „Data Type Float“

7.2 Modbus Settings (2001...2006)

Modbus Register	Modbus Address	No. of Byte	Data Type	Description	Default Setting	Read Write	Unit /Comment
2001	2000	2	UInt16	Modbus ID	1	R/W	Modbus ID 1...247
2002	2001	2	UInt16	Baudrate	4	R/W	0 = 1200 1 = 2400 2 = 4800 3 = 9600 4 = 19200 5 = 38400
2003	2002	2	UInt16	Parity	1	R/W	0 = none 1 = even 2 = odd
2004	2003	2	UInt16	Number of Stopbits		R/W	0 = 1 Stop Bit 1 = 2 Stop Bit
2005	2004	2	UInt16	Word Order	0xABCD	R/W	0xABCD = Big Endian 0xCDAB = Middle Endian
2006	2005	2	UInt16	Modbus Enabled	FA500: 1 FA510: 1 FA515: 0	R/W	0 = Modbus disabled 1 = Modbus Enabled

7.3 Analog Scaling Settings (2007...2011)

Modbus Register	Modbus Address	No. of Byte	Data Type	Description	Default Setting	Read Write	Unit /Comment
2007	2006	4	UInt32	Output Value	4	R/W	0 = 4-20mA disabled 1 = Temperature [°C] 2 = Temperature [°F] 3 = relative Humidity [%] 4 = DewPoint [°C] 5 = DewPoint [°F] 6 = Absolute Humidity [g/m3] 7 = Absolute Humidity [mg/m3] 8 = Humidity Grade [g/kg] 9 = Vapor Ratio [ppm] 10 = Saturation VaporPressure[hPa] 11 = Partial Vapor Pressure [hPa] 12 = Atmospheric DewPoint [°C] 13 = Atmospheric DewPoint [°F]
2009	2008	4	float	4mA Scale Low	-80	R/W	
2011	2010	4	float	20mA Scale High	20	R/W	

Modbus installation, Modbus settings and further information refer to the manual CS Instruments "**Modbus Installation and Operating Instructions FA 5xx sensors**"

8 Operation

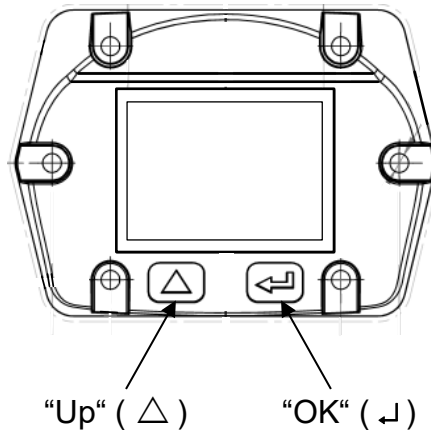

“Up“ (Δ)

“OK“ (\leftarrow)

The operation of the FA 500 is done by the two capacitive key buttons Up (Δ) and Enter (\leftarrow)

8.1 Initialization



After switching on the FA 500, the initialized screen is displayed followed by the main menu.

8.2 Main menu

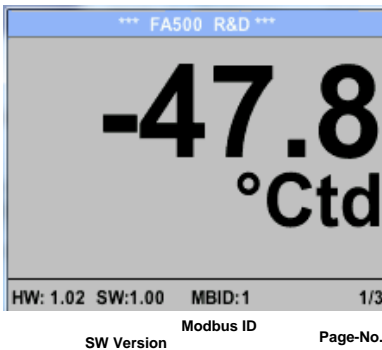

Page 1

Display value is the pressure dew point, here in °Ctd. (When measured under pressure)
The pressure dew point is always based on the pressure in the compressed air pipe.

Switching to pages 2-3 or back by pressing key „ Δ “

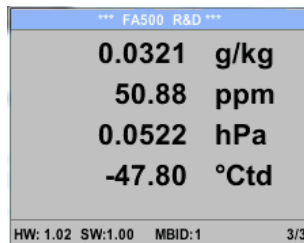
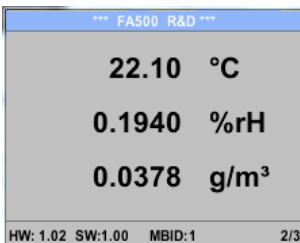

Page 3

Value 1: Absolute humidity in g/kg **
Value 2 Parts per Million **
Value 4: Atmospheric dew point (when the reference pressure is set to atmospheric pressure 1013,25 hPa) or reference dew point based on the reference pressure setting.

** For the calculation, the input of the system pressure is mandatory. For entering see chapter, see 8.3.2.

8.3 Settings

The settings menu could accessed by pressing the key „OK“. Nevertheless, the access to the *settings menu* is password protected.



Factory settings for password at the time of delivery: 0000 (4 times zero).

If required the password could be changed at *Setup–User setup–Password*.

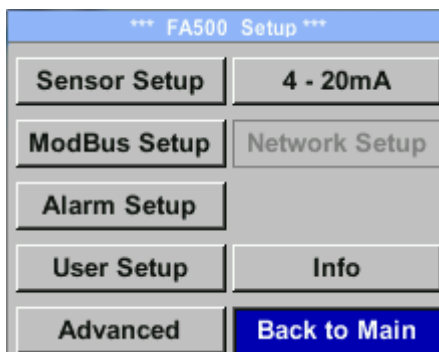

Selection of a menu item or to change a value is done with the key „ Δ “, a final move to the chosen menu item or takeover of the value change needs the confirmation by pressing the key „OK“

8.3.1 Sensor Settings

Settings → Sensor Setup



For changes, first select the menu item with key „ Δ “ **and** then confirm it with “OK”.

8.3.1.1 Definition of units for Temperature, pressure and abs. humidity

Settings → Sensor Setup → Units

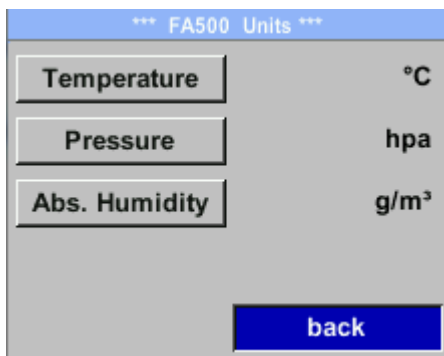

To make changes to the unit for the respective measurement value, first select by pressing „ Δ “ the field of the „measurement value“ and activate „it with „OK”.

Selection of the new unit with „ Δ “

In case the quantity of units selectable are not presentable on one page, please move to next page by pressing „ \ll “.

Confirm selection by pressing 2x „OK”.

Procedure for all 3 measurements variables is analogous.

Leaving the menu with „back”

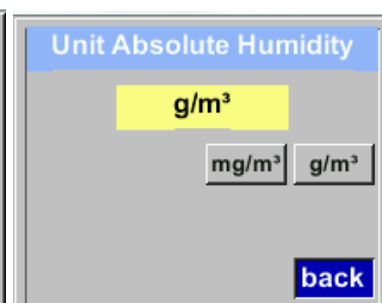
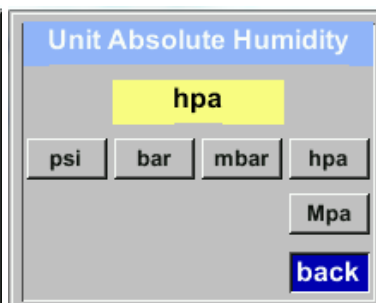
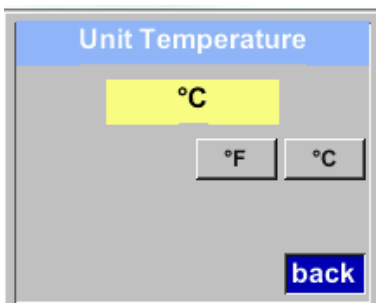

8.3.2 Definition of Reference- and System pressure

With the FA 500 the pressure dew point in the pressure line is measured automatically. The pressure dew point is always related to the pressure in the line.

A pressure input is not necessary, because the measuring principle measures independent of pressure.

The FA 500 is able simultaneously to the pressure dew point also calculate the atmospheric dew point or dew point at reduced pressure.

For the calculation of the atmospheric dew point (if the gas would be expanded to ambient pressure) or the dew point at reduced pressure, it is necessary to define the reference pressure and the system pressure.

Example:

The sensor is used in a compressed air line after a compressed air refrigeration dryer.

Pressure in the line: 6 bar (overpressure)

Measured pressure dew point: + 3 ° Ctd

To calculate the atmospheric dew point, the reference pressure (atmospheric pressure 1013,25 hPa) and the system pressure (overpressure) with 6bar must be entered.

Only after entering the two pressures, a correct calculation of the atmospheric dew point is possible. (Displayed on screen page 3, here the value 4)

Settings → Sensor Setup → Pressure

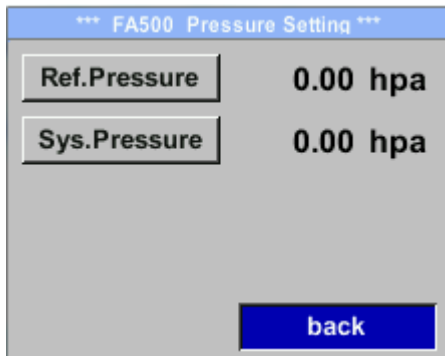

To make changes, first select a menu with button „ Δ “ and confirm selection by pressing „**OK**“.

Settings → Sensor Setup → Pressure → Ref. Pressure

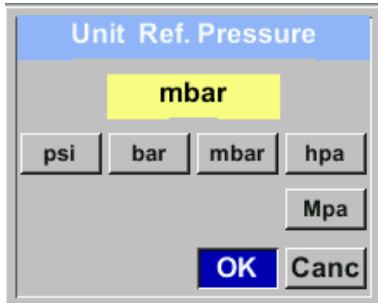
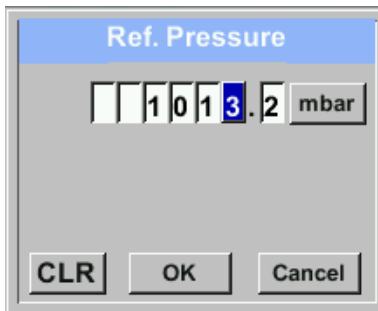

In order to change, e.g. the unit, first select by pressing key „ Δ “ the field “Units” and then key “**OK**”.

Select with the key „ Δ “ the correct unit and then confirm selection by pressing 2x „**OK**“.

Input / change of the value by selecting the respective position with button „ Δ “ and entering by pressing button „**OK**“ .

By pressing „ Δ “ the position value is incremented by 1. Complete input/change with “**OK**” and activate next number position.

Inputs / changes to be confirmed with button „**OK**“.

Procedure for entering / changing the system pressure is analogous.

Settings → Sensor Setup → Pressure → Sys. Pressure

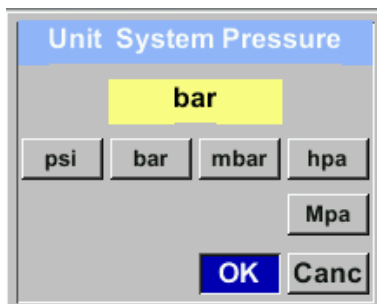

8.3.2.1 Calibration

Settings → Sensor Setup → Calibration

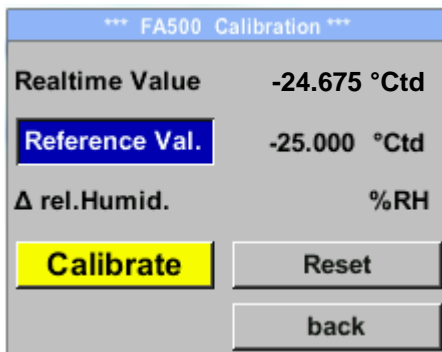
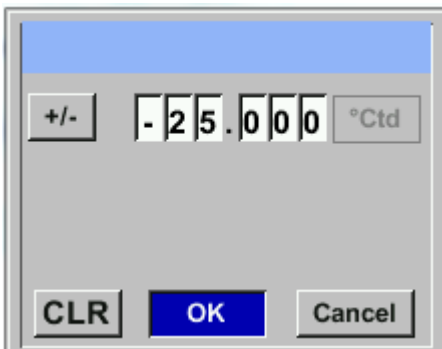
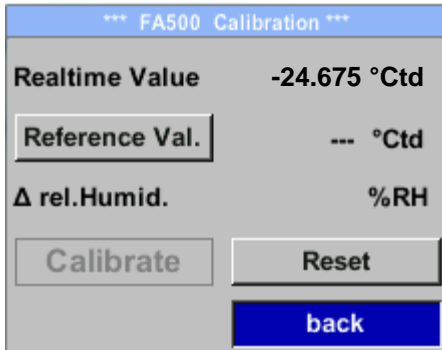

Here, a one-point calibration can be performed

For the Calibration select with button „ Δ “ the menu „*Reference Val.*“ and open the input menu with „**OK**“.

Input / change of the value by selecting the respective position with button „ Δ “ and entering by pressing button „**OK**“ .

By pressing the button „*Calibrate*“ the new reference value will be taken over.

A calibration could be set back to „out of factory“ settings with button „*Reset*“.

Leaving the menu with „*back*“

8.3.3 Modbus Setup

The Flow sensors VA 520 comes with a Modbus RTU Interface. Before commissioning the sensor the communication parameters

- Modbus ID, Baud rate, Parity und Stop bit

must be set in order to ensure the communication with the Modbus master.

Setup → Sensor Setup → Modbus Setup

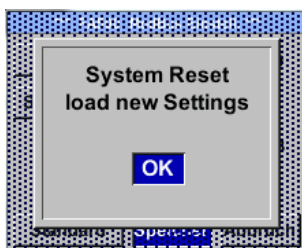
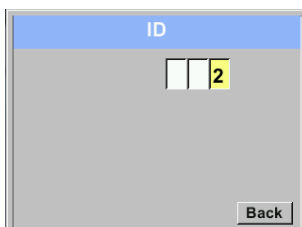
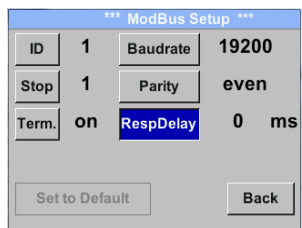

For changes, e.g. the sensor ID, first select by pressing key „**Δ**“ the field “**ID**” and then key “**OK**”.

Select the desired position by pressing the “>” and select with “**OK**” button.

Change values by pressing the „**Δ**“ values takeover by pressing “**OK**”.

Inputs for remaining information is analogous.

With “**Format**”, the word order of transmission could be changed between ABCD (Little Endian) and CDBA (Middle Endian).

Saving the changes by pressing “**Save**”, therefore select it first with key „**Δ**“ and afterwards confirm it with “**OK**”.

For the new settings the sensor needs a “**Reset**” (Restart) which needs to be confirmed with „**OK**”

With the button “**Default**” the settings are set back to “Out of factory” values

Default values out of factory:

Modbus ID:	1
Baud rate:	19200
Stop bit:	1
Parity:	even

Remark: If the sensor is placed at the end of the Modbus system a termination is required. The sensors have an internal switchable termination, therefore the 6 fastening screws from the lid are to be released and set the internal DIP Switch to “On”.

Alternatively, a 120R resistor can be installed in the plug between pin 2 and pin 4.

It must be ensured that the connection plugs are still plugged and the gasket is installed correctly..

8.3.4 Alarm

Settings → Alarm Setup

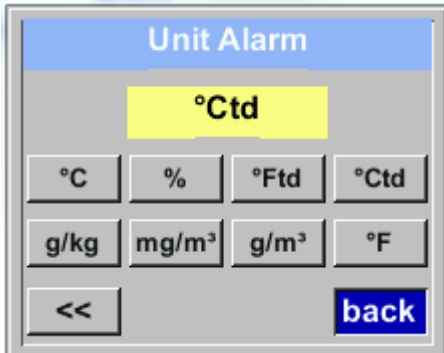
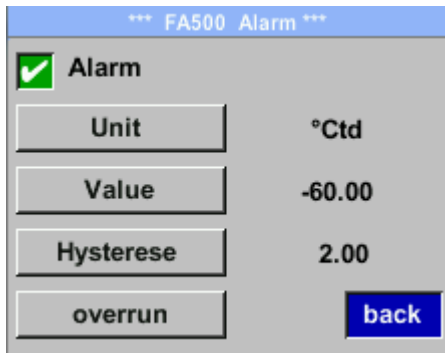

The Alarm could be activated / deactivated with the option button „Alarm“, selecting it with „ Δ “ and change it with button „OK“

Alarm deactivated.

Alarm activated.

The alarm could be set to one of the values (units), see picture „Unit Alarm“.

„Value“ defines the alarm value, here -60°Ctd .

„Hysteresis“ defines the hysteresis value

With button „overrun“ or „underrun“ the way how the alarm is triggered

Overrun: Value is exceeding the „Value“

Underrun: Value is going below „Value“

8.3.5 User Setup.

Settings → User Setup

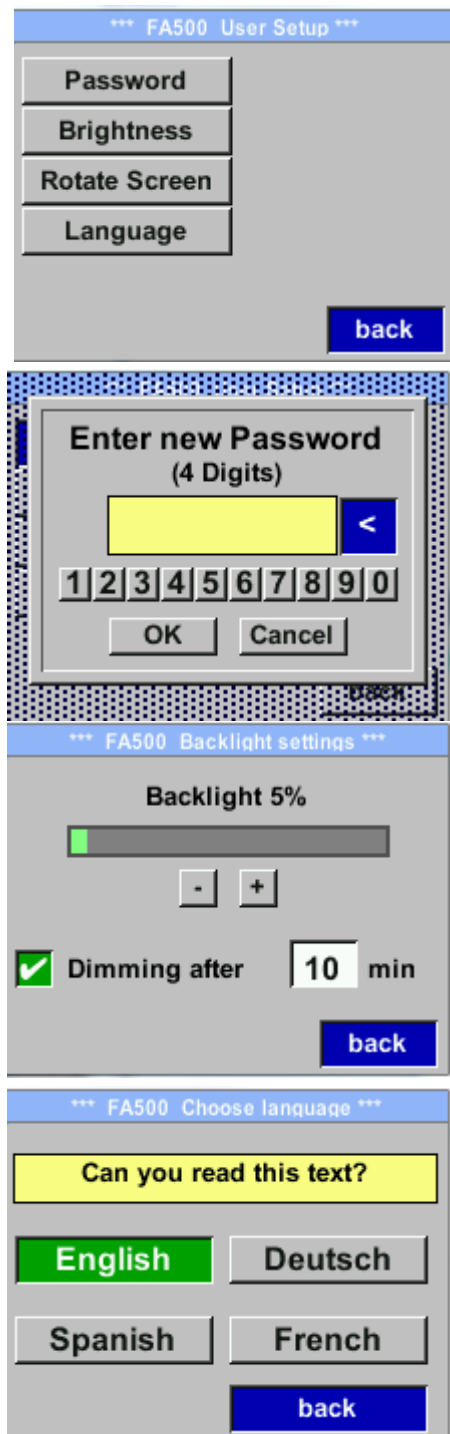

To make changes, first select a menu with button „ Δ “ and confirm selection by pressing „**OK**“ .

It is possible to define a password. The required password length is 4 digits. Please select with button „ Δ “ a figure and confirm it with „**OK**“ .Repeat these 4 times.

With „ \leftarrow “ the last figure could be deleted.

Password input have to be inserted twice.

Confirmation of input/password by pressing „**OK**“.

With button „**Brightness**“ could the display brightness adapted/changed. Therefore move with „ Δ “ either to the „+“ or „-“ button and change the brightness with „**OK**“.

With „**Dimming after**“ a display dimming could be activated. The dimming starts after the time period defined in time field. Trigger is last keypress .

„**Rotate Screen**“ will rotate the display content by 180°.

Currently there are 4 languages integrated which could be selected by means of button „ Δ “.

Language activation with activation of button „**back**“ and confirming with „**OK**“

8.3.6 4 -20mA

Settings → 4-20mA

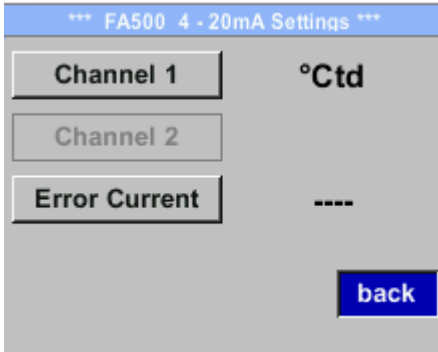

To make changes, first select a menu with button „ Δ “ and confirm selection by pressing „OK“.

Settings → 4-20mA → Channel 1 → Status

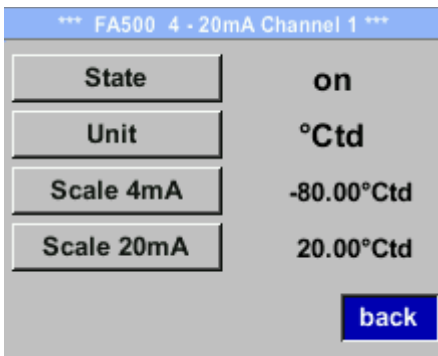

The 4-20 mA Analogue output of the Sensor FA 500 can be individually adjusted.

Activation „on“ or deactivation „off“ of the alarm by selecting button „State“ und and confirming with „OK“.

Settings → 4-20mA → Channel 1 Unit

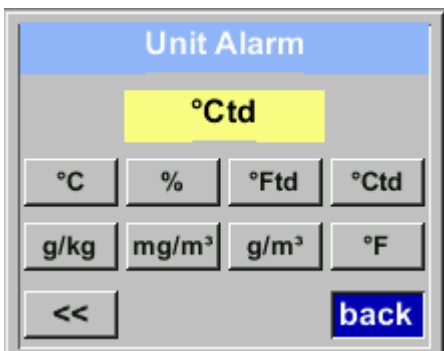

To select a measurement value, a corresponding / appropriate unit needs to be defined. Select „Unit“ with „ Δ “ and open the menu with „OK“. Select required unit with „ Δ “ and takeover it by pressing „OK“.

Settings → 4-20mA → Channel 1 → Scale 4mA

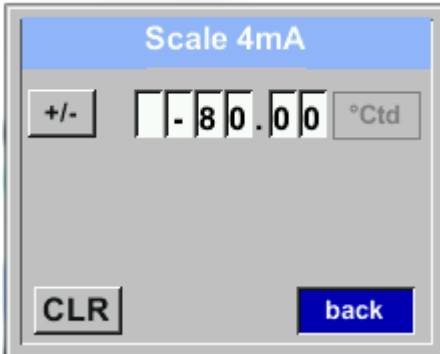

Settings → 4-20mA → Channel 1 Scale 20mA

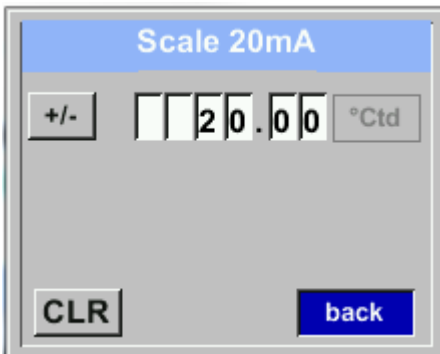

„Scale 4mA“ and „Scale 20mA“ allows defining the desired scaling.

With button „ Δ “ select the menu „Scale 4mA“ or „Scale 20mA“ and open it with „OK“

Input is analogous to that described above, using the „CLR“ the complete entry will be deleted.

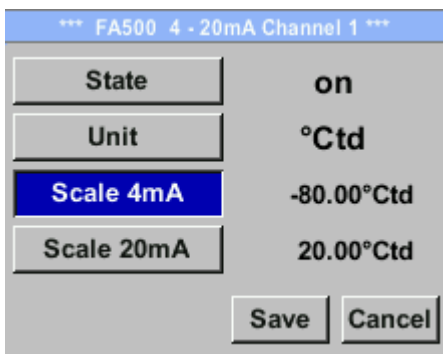

Takeover the inputs/changes with „Save“, or discard the changes with „Cancel“.

Leaving menu with „back“

Settings → 4-20mA → Channel 1 → Error Current

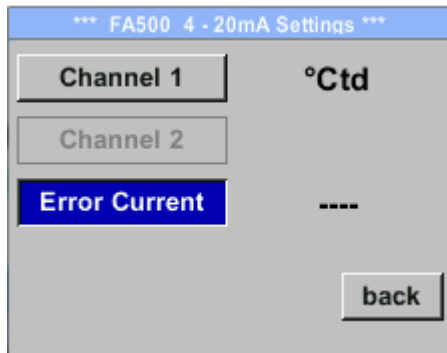

This determines what is output in case of an error at the analog output.

- 2 mA Sensor error / System error
- 22 mA Sensor error / System error
- None Output according Namur (3.8mA – 20.5 mA)
 < 4mA to 3.8 mA Measuring range under range
 >20mA to 20.5 mA Measuring range exceeding

To make changes first select a menu item "Current Error" with button „ Δ “ and then select by pressing the „OK“ the desired mode

With „back“ change to the settings menu.

8.3.7 FA 500 Info

Settings → Info



Here you get a brief description of the sensor data incl. some production data

9 Calibration / Adjustment

From the manufacturer

According to DIN ISO certification of the measuring instruments we recommend regular calibration and, if necessary, adjustment of the instrument by the manufacturer. The calibration cycles should fit your internal scheme. In the course of the DIN ISO certification, we recommend for FA 500 a calibration cycle of one year. If requested we can carry out the calibration on your premises.

10 Warranty

If you have reason for complaint, we will of course repair any faults free of charge if it can be proven that they are manufacturing faults. The fault should be reported immediately after it has been found and within the warranty time guaranteed by us. Excluded from this warranty is damage caused by improper use and non-adherence to the instruction manual.

The warranty is also cancelled once the measuring instrument has been opened provided this is not described in the instruction manual for maintenance purposes. This is also the case if the serial number has been changed, damaged or removed.

The warranty time for FA 500 is 12 months for the instrument and 6 months for accessories if no other terms have been agreed. Warranty services do not extend the warranty time.

If in addition to the warranty service necessary repairs, adjustments or similar are carried out, the warranty services are free of charge but there is a charge for other services such as transport and packing costs. Other claims, especially those for damage occurring outside the instrument are not included unless responsibility is legally binding.

After-sales service after the warranty time has elapsed

We are, of course, there for you after the warranty time has elapsed. In the case of function faults, please send us your measuring instrument with a brief description of the defect. Please also indicate your telephone number so that we can contact you if necessary.

11 Ordering details

<i>Bestell Nr.</i>	<i>Beschreibung</i>
0699.0501	FA 500 dew point sensor (-20...50 °Ctd)
0699.0502	FA 500 dew point sensor (-80...20 °Ctd)
0699.0503	FA 500 dew point sensor (-60...30 °Ctd)
0553.0104	Connection cable, length: 5 m
0553.0105	Connection cable, length:10 m
0699.3390	Standard measuring chamber for compressed air up to 16 bar
0699.3290	Measuring chamber Stainless steel (1.4305) for dew point measurement in gas / air.
0699.3590	High-pressure measuring chamber up to 350 bar *
0699.3690	Measuring chamber for atmospheric dew point
0699.3396	Precision calibration at -40 °Ctd or 3° Ctd incl. ISO certificate
0554.2007	CS Service Software for FA/VA sensors incl. PC connection set, USB connection and interface adapter to the sensor

CS Instruments GmbH & Co.KG

Geschäftsstelle Süd / Sales Office South /

Zindelsteiner Str. 15
D-78052 VS-Tannheim

Tel.: +49 (0) 7705 978 99 0

Fax: +49 (0) 7705 978 99 20

Mail: info@cs-instruments.com

Web: <http://www.cs-instruments.com>

Geschäftsstelle Nord / Sales Office North

Am Oxer 28c
D-24955 Harrislee

Tel.: +49 (0) 461 700 20 25

Fax: +49 (0) 461 700 20 26

Mail: info@cs-instruments.com

Web: <http://www.cs-instruments.com>

KONFORMITÄTSERKLÄRUNG

DECLARATION OF CONFORMITY

Wir
We

CS Instruments GmbH
Am Oker 28c, 24955 Harrislee

Erklären in alleiniger Verantwortung, dass das Produkt
Declare under our sole responsibility that the product

Feuchtesensoren FA 500
Dew point sensors FA 500

den Anforderungen folgender Richtlinien entsprechen:
We hereby declare that above mentioned components comply with requirements of the following EU directives:

Elektromagnetische Verträglichkeit Electromagnetic compatibility	2014/30/EU 2014/30/EC
---	--------------------------

Angewandte harmonisierte Normen:

Harmonised standards applied:

EMV-Anforderungen EMC requirements	EN 61326-1: 2006-10 2013-07 EN 61000-3-2 : 2015-3
---------------------------------------	--

Anbringungsjahr der CE Kennzeichnung: 16

Year of first marking with CE Label: 16

Das Produkt ist mit dem abgebildeten Zeichen gekennzeichnet.
The product is labeled with the indicated mark.



Harrislee, den 21.06.2016



Wolfgang Blessing Geschäftsführer